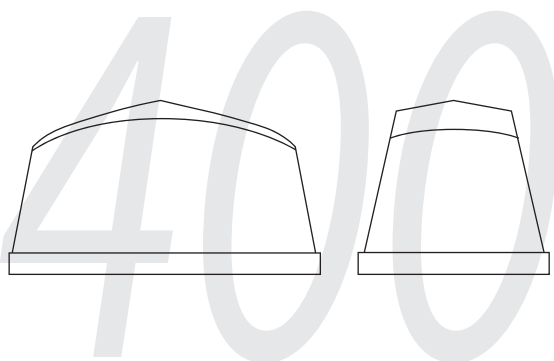

Silikontamponger - Serie 400

Silikontamponger - Serie 400 levereras i hårdheter 0-30 Shore A, tillverkas standard med träsockel med M6, aluminium eller stålsockel. Vi tillverkar också specialanpassade magnetklickfästen som gör det möjligt att snabbt byta silikontampong utan verktyg eller inställning.

Alla mått är cirkamått och angiven tryckyta gäller för plan tryckyta.

För mindre tryckytor och tampongmontage av flera små silikontamponger, se Serie 900 MINI.

BT433

 H
30

38 x 25

Tryckyta*: ca 25 x 20

BT495

 H
30

35 x 25

Tryckyta*: ca 25 x 20

BT177

 H
40

42 x 34

Tryckyta*: ca 27 x 20

BT470

 H
35

43 x 24

Tryckyta*: ca 30 x 16

BT432

 H
30

35 x 24

Tryckyta*: ca 30 x 18

BT494

 H
30

35 x 25





Tryckyta*: ca 30 x 18

<p>HAB419 <input type="checkbox"/></p>  <p>H 37</p> <p>46 x 34</p> <p>Tryckyta*: ca 30 x 22</p>	<p>BT210 <input type="checkbox"/></p>  <p>H 42</p> <p>Ø 45</p> <p>Tryckyta*: ca 32 x 24</p>	<p>BT231 <input type="checkbox"/></p>  <p>H 45</p> <p>55 x 26</p> <p>Tryckyta*: ca 34 x 15</p>
<p>HAB402 <input type="checkbox"/></p>  <p>H 38</p> <p>44 x 35</p> <p>Tryckyta*: ca 34 x 25</p>	<p>T90/1 <input type="checkbox"/></p>  <p>H 45</p> <p>55 x 25</p> <p>Tryckyta*: ca 35 x 16</p>	<p>BT43 <input type="checkbox"/></p>  <p>H 43</p> <p>Ø 47</p> <p>Tryckyta*: ca 38 x 20</p>
<p>T20 <input type="checkbox"/></p>  <p>H 33</p> <p>54 x 37</p> <p>Tryckyta*: ca 40 x 20</p>	<p>T20/1 <input type="checkbox"/></p>  <p>H 33</p> <p>54 x 37</p> <p>Tryckyta*: ca 40 x 26</p>	<p>BT348 <input type="checkbox"/></p>  <p>H 35</p> <p>54 x 29</p> <p>Tryckyta*: ca 40 x 29</p>

<p>BT514</p>  <p>H 66</p> <p>72 x 64</p> <p>Tryckyta*: ca 40 x 40</p>	<p>T90</p>  <p>H 45</p> <p>55 x 25</p> <p>Tryckyta*: ca 42 x 16</p>	<p>BT277</p>  <p>H 44</p> <p>82 x 45</p> <p>Tryckyta*: ca 42 x 30 Stålsöcket / M6 - C60</p>
<p>BT21</p>  <p>H 46</p> <p>52 x 25</p> <p>Tryckyta*: ca 44 x 15</p>	<p>BT525</p>  <p>H 49</p> <p>59 x 39</p> <p>Tryckyta*: ca 45 x 25</p>	<p>BT491</p>  <p>H 50</p> <p>59 x 34</p> <p>Tryckyta*: ca 45 x 25</p>
<p>BT203</p>  <p>H 33</p> <p>56 x 38</p> <p>Tryckyta*: ca 45 x 27</p>	<p>HAB410</p>  <p>H 42</p> <p>60 x 40</p> <p>Tryckyta*: ca 45 x 28</p>	<p>T70</p>  <p>H 47</p> <p>56 x 33</p> <p>Tryckyta*: ca 45 x 28</p>



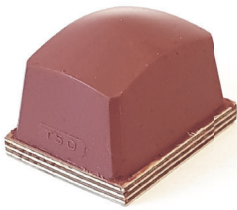
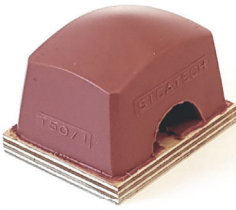



BT164	 <p>H 47</p>	HAB403	 <p>H 48</p>	BT233	 <p>H 48</p>
59 x 36		60 x 45		55 x 44	
Tryckyta*: ca 45 x 32		Tryckyta*: ca 45 x 32		Tryckyta*: ca 48 x 35	
T113	 <p>H 60</p>	BT288	 <p>H 50</p>	T68	 <p>H 52</p>
66 x 63		64 x 35		79 x 35	
Tryckyta*: ca 48 x 44		Tryckyta*: ca 50 x 24		Tryckyta*: ca 50 x 24	
BT488	 <p>H 50</p>	BT215	 <p>H 55</p>	T36	 <p>H 57</p>
65 x 32		60 x 42		64 x 48	
Tryckyta*: ca 50 x 25		Tryckyta*: ca 50 x 30		Tryckyta*: ca 50 x 35	

BT170	T76	BT469
		
<p>61 x 28</p>	<p>74 x 45</p>	<p>65 x 35</p>
<p>Tryckyta*: ca 52 x 20</p>	<p>Tryckyta*: ca 54 x 26</p>	<p>Tryckyta*: ca 55 x 20</p>
T110	BT217	T50
		
<p>79 x 49</p>	<p>68 x 59</p>	<p>73 x 59</p>
<p>Tryckyta*: ca 58 x 30</p>	<p>Tryckyta*: ca 56 x 40</p>	<p>Tryckyta*: ca 58 x 40</p>
T50/1	BT337	HAB407
		
<p>73 x 59</p>	<p>85 x 34</p>	<p>78 x 38</p>
<p>Tryckyta*: ca 58 x 40</p>	<p>Tryckyta*: ca 60 x 25</p>	<p>Tryckyta*: ca 60 x 28</p>

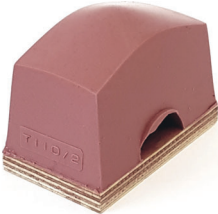
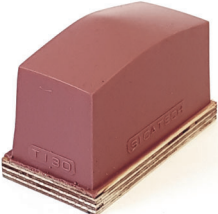
BT485	BT534	HAB404
		
81 x 53	84 x 55	74 x 54
Tryckyta*: ca 60 x 30	Tryckyta*: 60 x 30	Tryckyta*: ca 60 x 40
BT214	BT216	T106
		
86 x 35	79 x 51	82 x 56
Tryckyta*: ca 65 x 22	Tryckyta*: ca 65 x 34	Tryckyta*: ca 65 x 34
T49	T411	T412
		
82 x 60	100 x 75	94 x 75
Tryckyta*: ca 65 x 40 Aluminiumsockel / M6	Tryckyta*: ca 65 x 55	Tryckyta*: ca 65 x 55

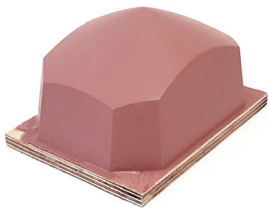

T60/1	BT223	T80
		
<p>90 x 55</p>	<p>88 x 58</p>	<p>83 x 37</p>
<p>Tryckyta*: ca 68 x 20</p>	<p>Tryckyta*: ca 70 x 20</p>	<p>Tryckyta*: ca 70 x 26</p>
T110/1	HAB409	HAB405
		
<p>83 x 50</p>	<p>85 x 52</p>	<p>92 x 66</p>
<p>Tryckyta*: ca 70 x 38</p>	<p>Tryckyta*: ca 70 x 40</p>	<p>Tryckyta*: ca 70 x 45</p>
BT400	BT401	BT276
		
<p>105 x 70</p>	<p>105 x 70</p>	<p>104 x 69</p>
<p>Tryckyta*: ca 70 x 50</p>	<p>Tryckyta*: 70 x 50</p>	<p>Tryckyta*: ca 70 x 55</p>

T98.1	BT253	T111/1
		
84 x 72	95 x 57	88 x 63
Tryckyta*: ca 70 x 60	Tryckyta*: ca 72 x 39	Tryckyta*: ca 72 x 48
T110/2	BT371	T98
		
83 x 50	99 x 76	84 x 72
Tryckyta*: ca 74 x 39	Tryckyta*: ca 75 x 60	Tryckyta*: ca 75 x 62
T130	BT372	T121
		
93 x 47	97 x 90	100 x 70
Tryckyta*: ca 80 x 32 (special)	Tryckyta*: ca 80 x 70	Tryckyta*: ca 83 x 58

T128	T111/2	HAB408
		
96 x 38	96 x 60	100 x 50
Tryckyta*: ca 84 x 21	Tryckyta*: ca 84 x 48	Tryckyta*: ca 85 x 38
T406	BT255	T84
		
110 x 77	103 x 73	105 x 77
Tryckyta*: ca 85 x 56	Tryckyta*: ca 85 x 58	Tryckyta*: ca 85 x 58
BT270	BT89	T123
		
140 x 104	100 x 66	98 x 89
Tryckyta*: ca 85 x 75	Tryckyta*: 86 x 54	Tryckyta*: ca 87 x 75

T29	BT479	BT267
		
<p>130 x 60</p>	<p>126 x 66</p>	<p>145 x 75</p>
<p>Tryckyta*: ca 100 x 35</p>	<p>Tryckyta*: ca 100 x 38</p>	<p>Tryckyta*: ca 100 x 40</p>
T38	T61	BT338
		
<p>115 x 85</p>	<p>131 x 61</p>	<p>136 x 44</p>
<p>Tryckyta*: ca 100 x 66</p>	<p>Tryckyta*: ca 105 x 55</p>	<p>Tryckyta*: ca 110 x 35</p>
BT302	T31	T35
		
<p>131 x 84</p>	<p>132 x 46</p>	<p>138 x 100</p>
<p>Tryckyta*: ca 110 x 57</p>	<p>Tryckyta*: ca 115 x 30</p>	<p>Tryckyta*: ca 115 x 75</p>

BT186	T99	BT339
		
160 x 125	159 x 128	194 x 108
Tryckyta*: ca 115 x 80	Tryckyta*: ca 125 x 98	Tryckyta*: ca 150 x 78
HAB417	BT285	BT528
		
200 x 110	179 x 134	170 x 140
Tryckyta*: ca 150 x 85	Tryckyta*: ca 150 x 110	Tryckyta*: ca 155 x 125
BT376	T97	T201
		
198 x 45	195 x 98	193 x 96
Tryckyta*: ca 165 x 34	Tryckyta*: ca 165 x 38	Tryckyta*: ca 175 x 68

<p>BT187</p>	<p>T96</p>	
 <p>H 125</p>	 <p>H 130</p>	
<p>228 x 129</p>	<p>282 x 102</p>	
<p>Tryckyta*: ca 180 x 85</p>	<p>Tryckyta*: ca 240 x 55</p>	<p>Tryckyta*: ca</p>
<p>Tryckyta*: ca</p>	<p>Tryckyta*: ca</p>	<p>Tryckyta*: ca</p>
<p>Tryckyta*: ca</p>	<p>Tryckyta*: ca</p>	<p>Tryckyta*: ca</p>

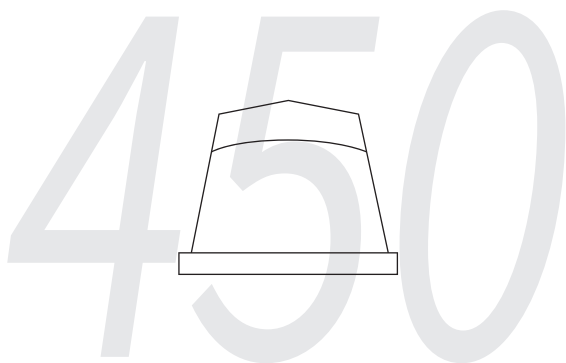
Silikontamponger - Serie 450



Silikontamponger - Serie 450 levereras i hårdheter 0-30 Shore A, tillverkas standard med träsockel med M6, aluminium eller stålsockel. Vi tillverkar också specialanpassade magnetklickfästen som gör det möjligt att snabbt byta silikontampong utan verktyg eller inställning.

Alla mått är cirkamått och angiven tryckyta gäller för plan tryckyta.

För mindre tryckytor och tampongmontage av flera små silikontamponger, se Serie 900 MINI.

<p>T33</p>  <p>H 36</p> <p>34 x 34</p> <p>Tryckyta*: ca 26 x 26</p>	<p>BT281</p>  <p>H 50</p> <p>43 x 43</p> <p>Tryckyta*: ca 36 x 36</p>	<p>BT434</p>  <p>H 50</p> <p>44 x 44</p> <p>Tryckyta*: ca 36 x 36</p>
<p>BT208</p>  <p>H 42</p> <p>47 x 47</p> <p>Tryckyta*: ca 38 x 38</p>	<p>T89</p>  <p>H 43</p> <p>50 x 50</p> <p>Tryckyta*: ca 38 x 38</p>	<p>T126</p>  <p>H 60</p> <p>64 x 64</p> <p>Tryckyta*: ca 40 x 40</p>

<p>BT165 <input type="checkbox"/></p>  <p>H 65</p> <p>78 x 78</p> <p>Tryckyta*: ca 50 x 50</p>	<p>BT535 <input type="checkbox"/></p>  <p>H 56</p> <p>70 x 65</p> <p>Tryckyta*: ca 50 x 50</p>	<p>BT146 <input type="checkbox"/></p>  <p>H 64</p> <p>70 x 70</p> <p>Tryckyta*: ca 56 x 56</p>
<p>BT67 <input type="checkbox"/></p>  <p>H 50</p> <p>77 x 77</p> <p>Tryckyta*: ca 56 x 56</p>	<p>T52 <input type="checkbox"/></p>  <p>H 66</p> <p>78 x 78</p> <p>Tryckyta*: ca 60 x 60</p>	<p>T19 <input type="checkbox"/></p>  <p>H 66</p> <p>94 x 94</p> <p>Tryckyta*: ca 68 x 68</p>
<p>BT418 <input type="checkbox"/></p>  <p>H 98</p> <p>109 x 114</p> <p>Tryckyta*: ca 100 x 100</p>	<p>BT167 <input type="checkbox"/></p>  <p>H 108</p> <p>142 x 142</p> <p>Tryckyta*: ca 105 x 105</p>	<p>BT168 <input type="checkbox"/></p>  <p>H 100</p> <p>140 x 140</p> <p>Tryckyta*: ca 120 x 120</p>

<p>BT426</p>		
 <p>H 100</p>		
<p>139 x 139</p>		
<p>Tryckyta*: ca 120 x 120</p>	<p>Tryckyta*: ca</p>	<p>Tryckyta*: ca</p>
<p>Tryckyta*: ca</p>	<p>Tryckyta*: ca</p>	<p>Tryckyta*: ca</p>
<p>Tryckyta*: ca</p>	<p>Tryckyta*: ca</p>	<p>Tryckyta*: ca</p>